

# DIMENSIONAL DATA 1 INCHES - CS FRAME

FOR CONCEALED SPLINE AND FINELINE CEILINGS

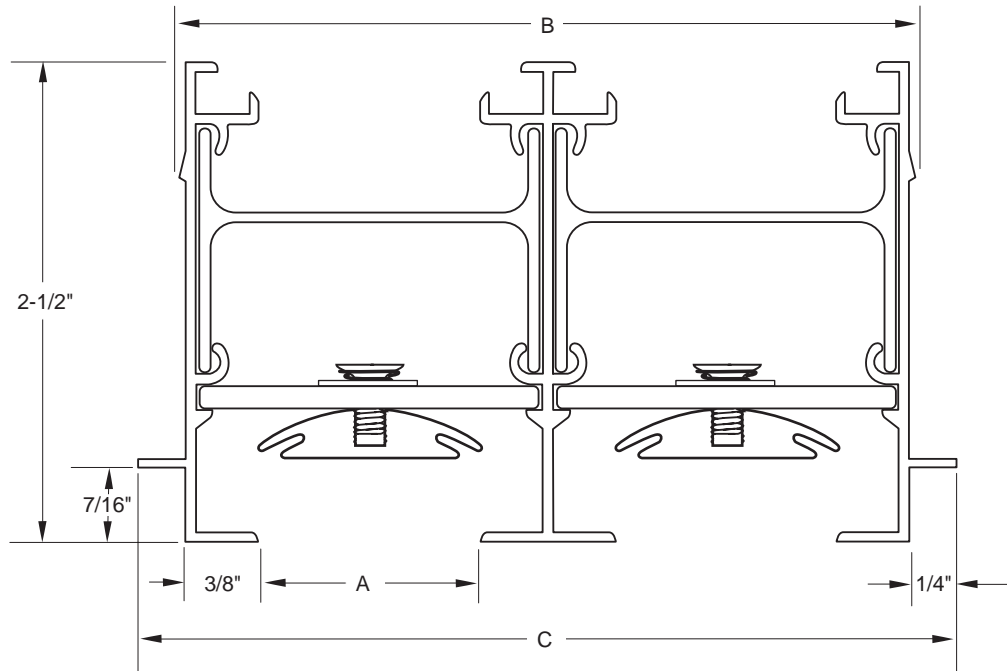

MODEL	SLOT	A	B	C
201-100 CS	1	1	1-13/16	2-1/4
202-100 CS	2	1	3-1/2	3-15/16
203-100 CS	3	1	5-3/16	5-5/8
204-100 CS	4	1	6-7/8	7-5/16
205-100 CS	5	1	8-9/16	9
206-100 CS	6	1	10-1/4	10-11/16
207-100 CS	7	1	11-15/16	12-3/8
208-100 CS	8	1	13-5/8	14-1/16

(Dimensions in inches)

**Note:**

- 1) See plenum details for various applications.
- 2) Diffuser neck supplied 1/4" undersize in overall length for concealed spline.
- 3) Diffuser neck supplied 9/16" undersize in overall length for fineline ceilings.
- 4) Greater number of slots are available.
- 5) Normally supplied with butt style end caps.