

DIMENSIONAL DATA 2 INCHES - LTSC FRAME DIRECT THROW

FOR CONCEALED MOUNTING WITH HEMMED PLENUM

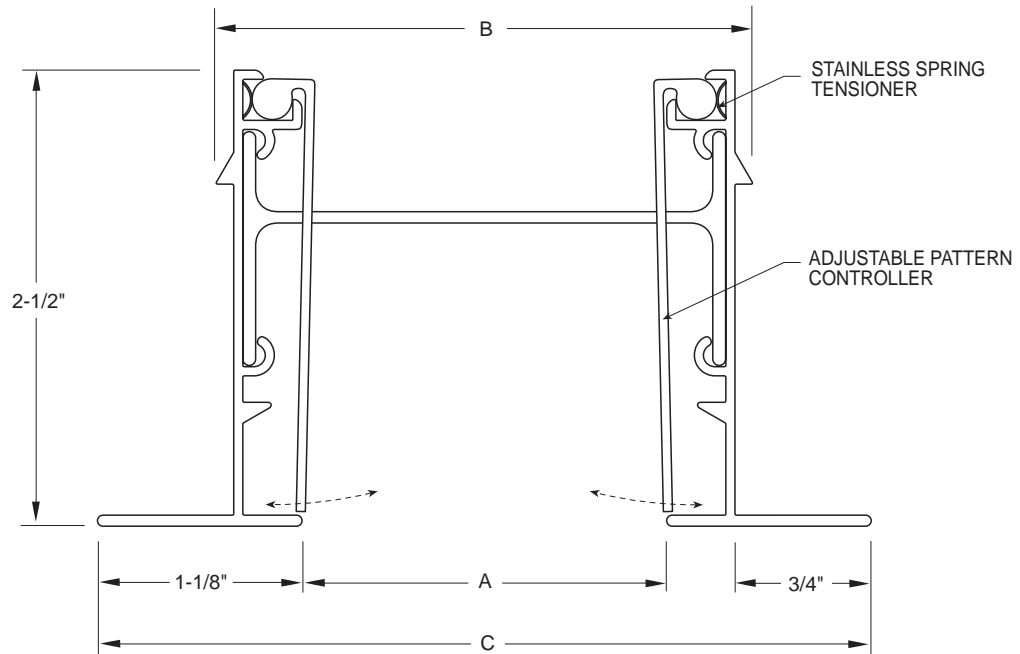

MODEL	SLOT	A	B	C
201-200 LT-DT	1	2	2-15/16	4-1/4
202-200 LT-DT	2	2	5-5/8	6-15/16

(Dimensions in inches)

Note:

- 1) See plenum details for various applications.
- 2) Diffuser neck supplied 1/4" undersize in overall length.
- 3) Sidewall application will be the same dimensionally.
- 4) Greater number of slots are available.
- 5) End caps (FC) add 2" to nominal length.