

DIMENSIONAL DATA 1 INCHES - LTTB FRAME

FOR T-BAR CEILING INSTALLATIONS

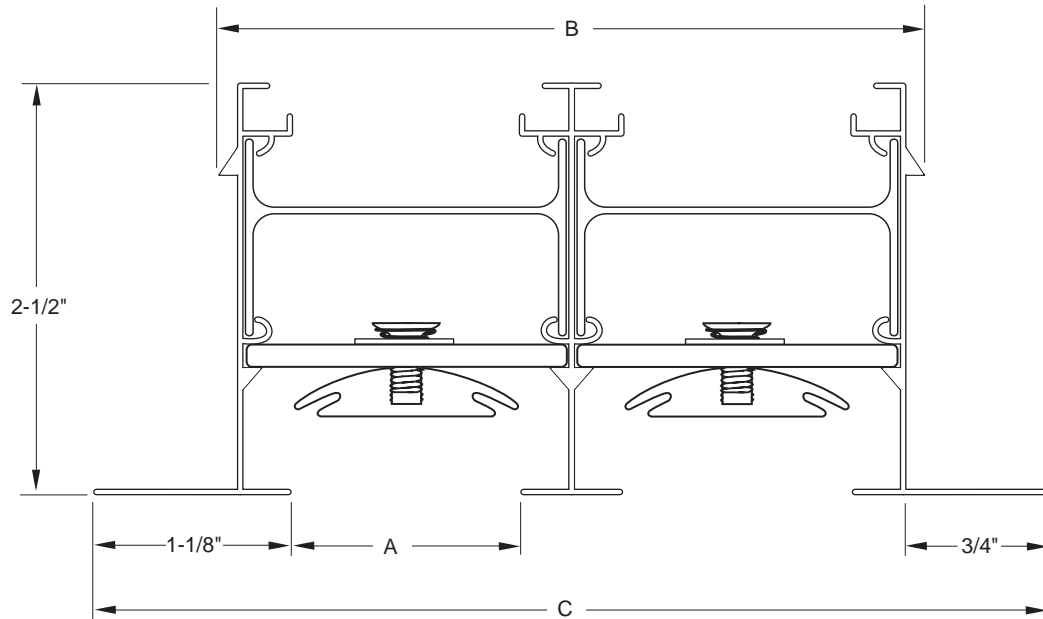

MODEL	SLOT	A	B	C
201-100 LTTB	1	1	1-15/16	3-1/4
202-100 LTTB	2	1	3-5/8	4-15/16
203-100 LTTB	3	1	5-5/16	6-5/8
204-100 LTTB	4	1	7	8-5/16
205-100 LTTB	5	1	8-11/16	10
206-100 LTTB	6	1	10-3/8	11-11/16
207-100 LTTB	7	1	12-1/16	13-3/8
208-100 LTTB	8	1	13-3/4	15-1/16

(Dimensions in inches)

Note:

- 1) See plenum details for various applications.
- 2) Diffuser neck supplied 1/4" undersize in overall length.
- 3) Greater number of slots are available.
- 4) Normally supplied with butt style end caps.